

Stage Series 2" Sport Yellow Standard LED Pod



FEATURES

STAGE
SERIES



- Modern TIR optics for the highest intensity on the market
- Backlighting in a brilliant amber color
- Durable powdercoated aluminum construction
- Integrated Deutsch-style connector
- Pin-fin heatsink design
- Designed, torture tested and assembled in USA

GENERAL SPECIFICATIONS

Optic	Peak Beam Intensity (Candela)	Illuminance (lux @10m)	Measured Output (Lumens)	Raw Output (Lumens)	Output Color
Driving	27,000 cd	270 lux	777 lm	960 lm	Selective Yellow
Flood	315 cd	3 lux	777 lm	960 lm	Selective Yellow
Fog	4,400 cd	44 lux	777 lm	960 lm	Selective Yellow
Combo	13,500 cd	135 lux	777 lm	960 lm	Selective Yellow
Spot	60,000 cd	600 lux	777 lm	960 lm	Selective Yellow

Functions: Yellow Output with Amber Backlight

Voltage Range: 9-16V

Current Draw (amps @ 12.8V): 595.7mA (output), 55.3mA (backlight)

Wattage: 7.62W (output), 708mW (backlight)

Connector Type: 4 Pin DT Connector

Driver Type: Integrated Driver

LED Type/Count: Luxeon Z ES 4K/2 total, 3014 Amber/6 total

Compliance Rating: J575 Durability Test, SAE-F J583, SAE-Y J581

Intrusion Rating: IP67 Weatherproof

Operating Temperature: -40°C to 85°C

What's Included:

- One (1) or Two (2) Stage Series 2" LED Pods
- One (1) or Two (2) Deutsch-style wire pigtails
- One (1) or Two (2) Mounting brackets and hardware

Dimensions & Weight:

Length: 12.5" **Width:** 5" **Height:** 3.5"

Weight: 1.1 lbs (single), 1.65 lbs (pair)

SKUs: Append "S" to the end of each SKU for single and "P" for pair

DD6383 Stage Series 2" Sport Yellow Driving Standard ABL
DD6386 Stage Series 2" Sport Yellow Fog Standard ABL

DD6391 Stage Series 2" Sport Yellow Combo Standard ABL
DD6396 Stage Series 2" Sport Yellow Flood Standard ABL

DD6401 Stage Series 2" Sport Yellow Spot Standard ABL

All data and specifications are nominal values and may vary.

PUBLISHED: 1-26-2021

COLORIMETRIC SPECIFICATIONS

YELLOW MAIN BEAM

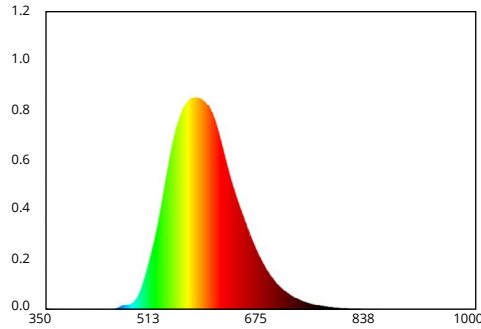

Spectral Distribution

CHROMATICITY

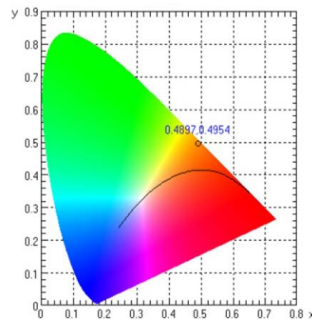

X=0.4897, Y=0.4954

AMBER BACKLIGHT

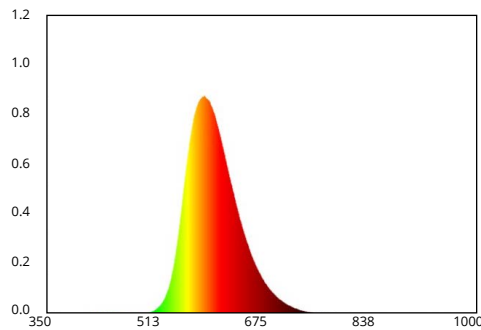

Spectral Distribution

CHROMATICITY

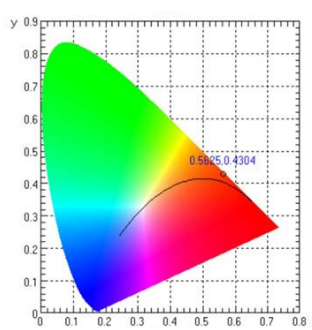

X=0.5625, Y=0.4304

PRODUCT DIMENSIONS

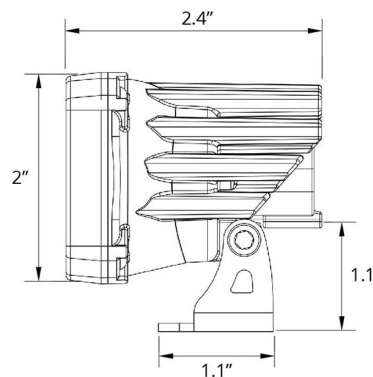
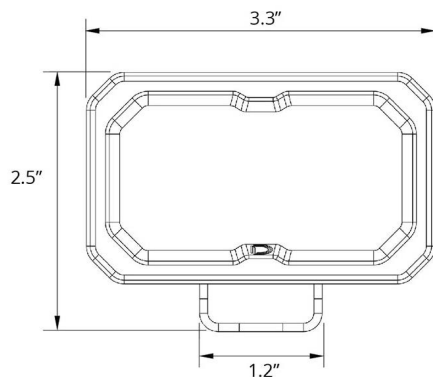

PUBLISHED: 1-26-2021

PHOTOMETRIC SPECIFICATIONS

Driving Optic Isolux

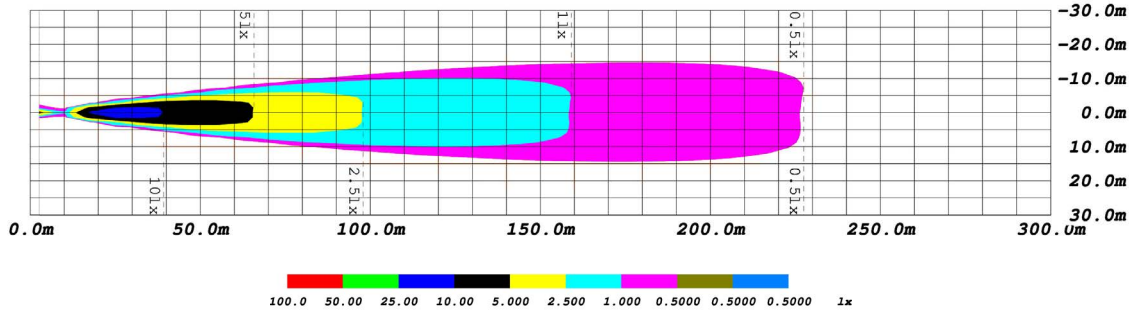

Driving Optic Perspective

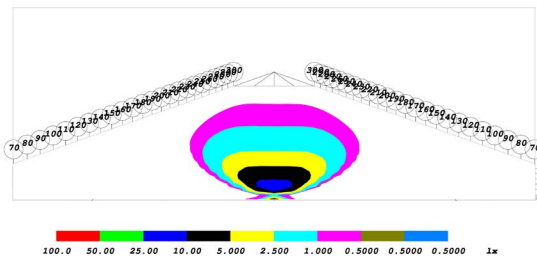

Driving Optic Isocandela

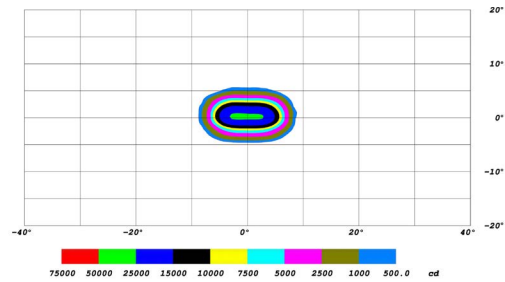

Fog Optic Isolux

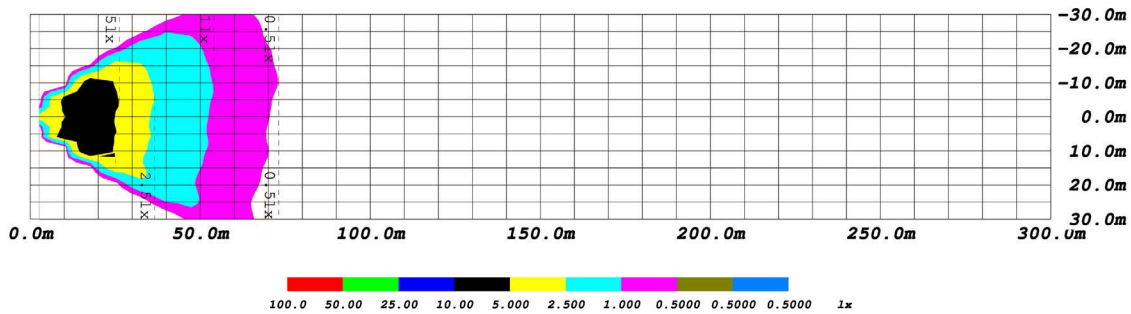

Fog Optic Perspective

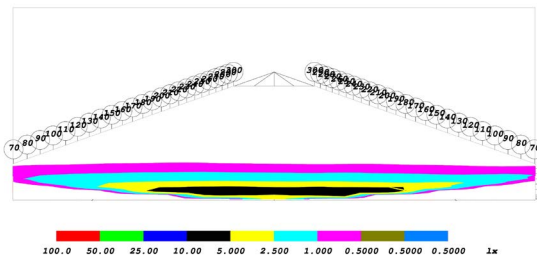

Fog Optic Isocandela

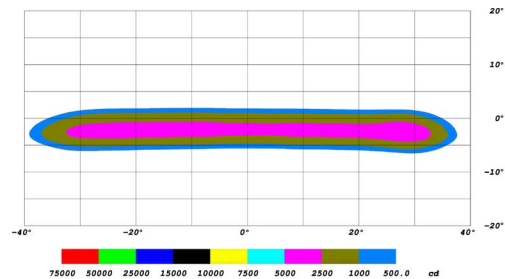

PUBLISHED: 1-26-2021

PHOTOMETRIC SPECIFICATIONS (cont.)

Combo Optic Isolux

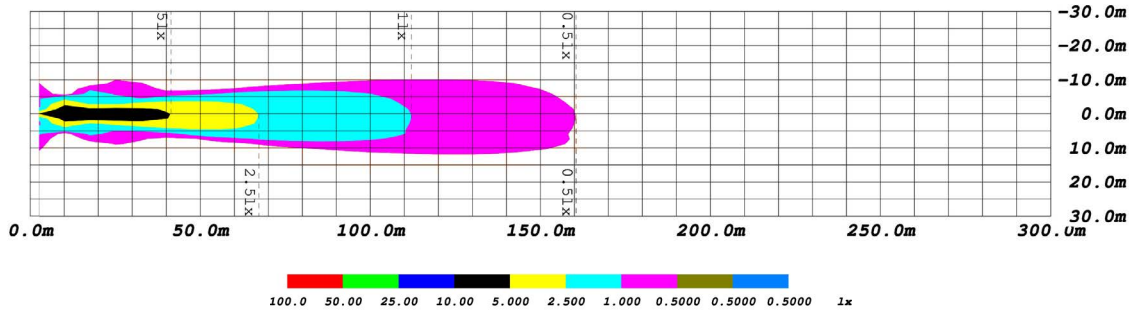

Combo Optic Perspective

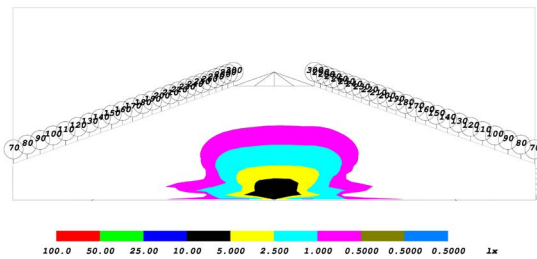

Combo Optic Isocandela

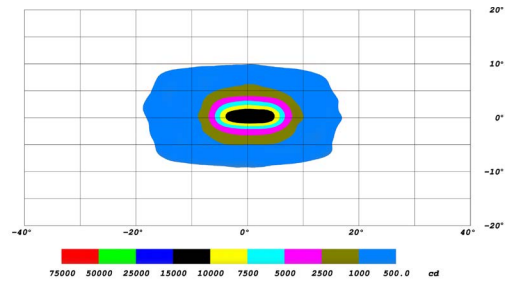

Flood Optic Isolux

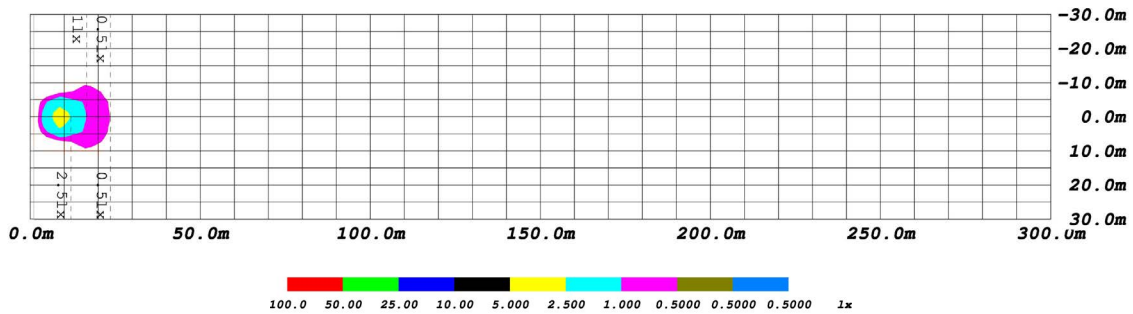

Flood Optic Perspective

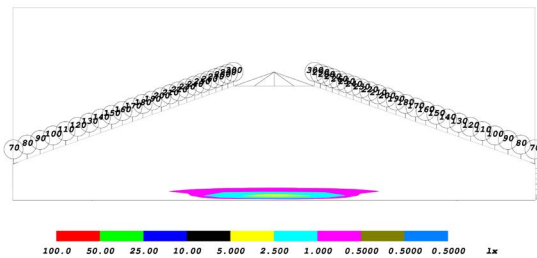

Flood Optic Isocandela

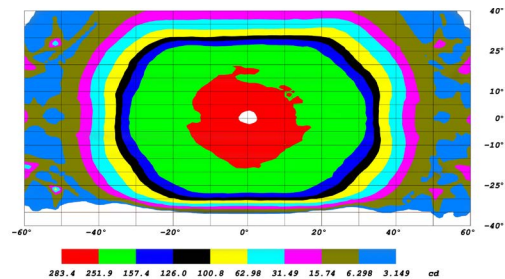

PUBLISHED: 1-26-2021

PHOTOMETRIC SPECIFICATIONS (cont.)

Spot Optic Isolux

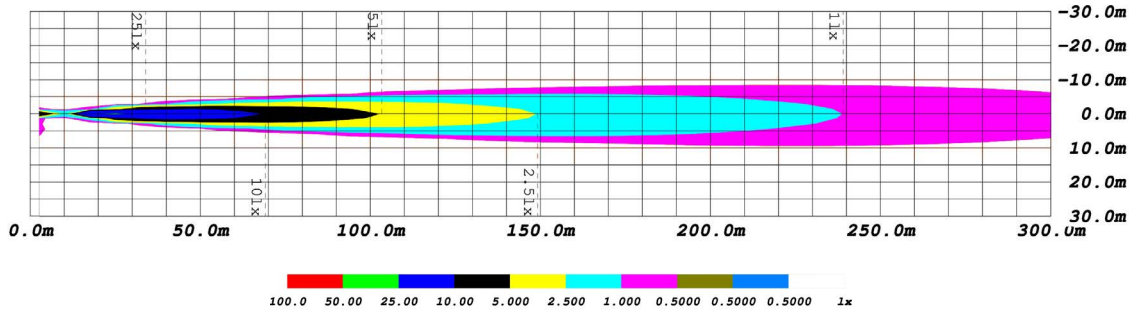

Spot Optic Perspective

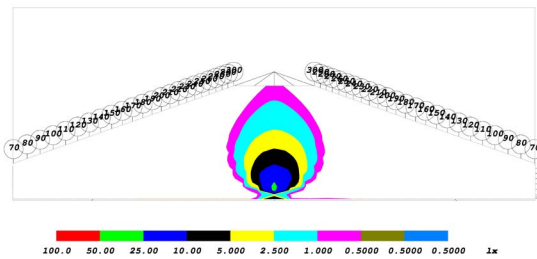

Spot Optic Isocandela

