

SSC1 SAE Fog Yellow Standard LED Pod



FEATURES

- Ultra-compact, single-LED form factor
- Single automotive-grade Osram Boost HX 20-watt LED
- Backlighting in a brilliant amber color
- Durable powdercoated aluminum construction
- Integrated Deutsch-style connector
- Designed, torture tested and assembled in USA

GENERAL SPECIFICATIONS

Optic	Peak Beam Intensity (Candela)	Illuminance (lux @10m)	Raw Lumens	Output Color
SAE Fog	4,200 cd	38 lux	1,980 lm	Selective Yellow

Functions: Yellow Output with Amber Backlight

Voltage Range: 9-16V

Current Draw (amps @ 12.8V): 1.5A (output), 25mA (backlight)

Wattage: 19.2W (output), 0.3W (backlight)

Connector Type: 4 Pin DT Connector

Driver Type: Integrated Driver

LED Type/Count: Osram Boost HX/1 total, 3014 Amber CSP/3 total

Compliance Rating: SAE J575 Durability Test,
SAE J583 Foglamp Beam Pattern

Intrusion Rating: IP68 Weatherproof

Operating Temperature: -40°C to 85°C

What's Included:

- One (1) or Two (2) SSC1 Standard LED Pods
- One (1) or Two (2) Deutsch-style wire pigtails
- One (1) or Two (2) Mounting brackets and hardware

Dimensions & Weight:

Length: 7.5" **Width:** 4.5" **Height:** 3"

Weight: 0.7 lbs (single), 1.2 lbs (pair)

SKUs: Append "S" to the end of each SKU for single and "P" for pair

DD6848 SSC1 SAE/DOT Fog Yellow Standard ABL

All data and specifications are nominal values and may vary.

PUBLISHED: 12-6-2023

COLORIMETRIC SPECIFICATIONS

YELLOW MAIN BEAM

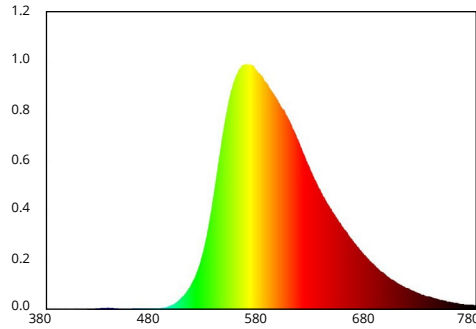

Spectral Distribution

CHROMATICITY

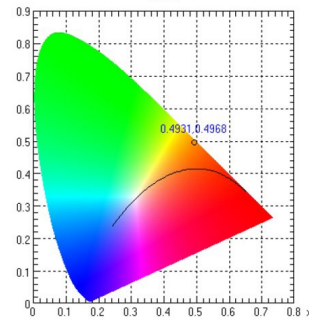

X=0.4931, Y=0.4968

AMBER BACKLIGHT

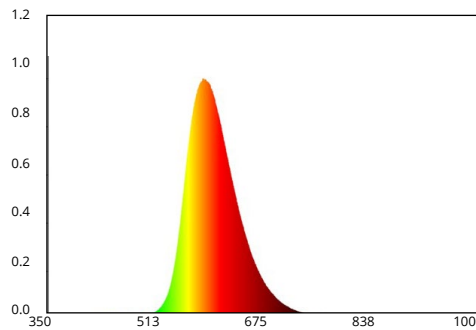

Spectral Distribution

CHROMATICITY

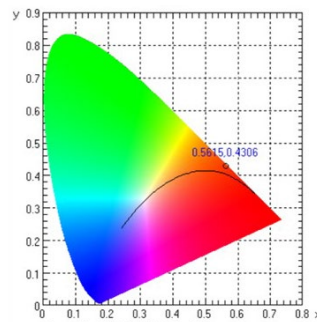

X=0.5615, Y=0.4306

PRODUCT DIMENSIONS

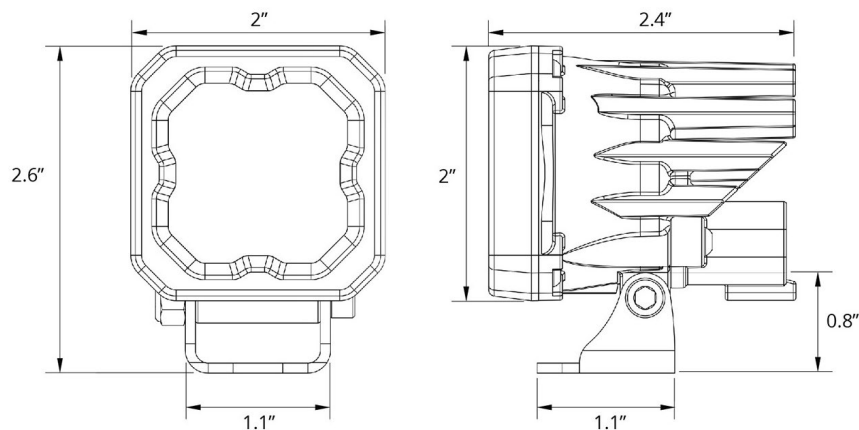

PUBLISHED: 12-6-2023

PHOTOMETRIC SPECIFICATIONS

SAE Fog Optic Isolux

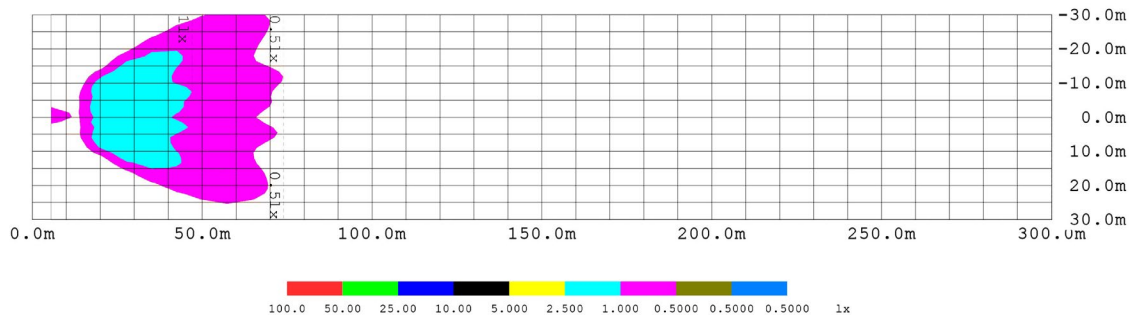

SAE Fog Optic Perspective

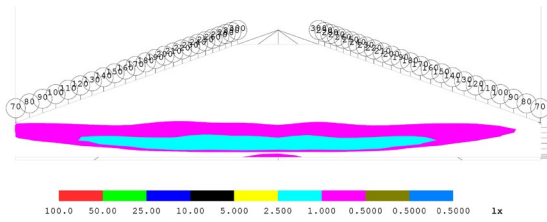

SAE Fog Optic Isocandela

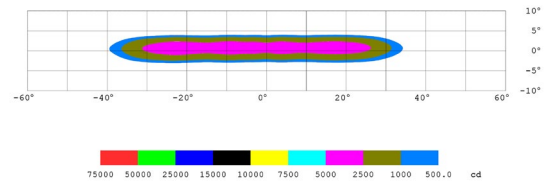

PUBLISHED: 12-6-2023